

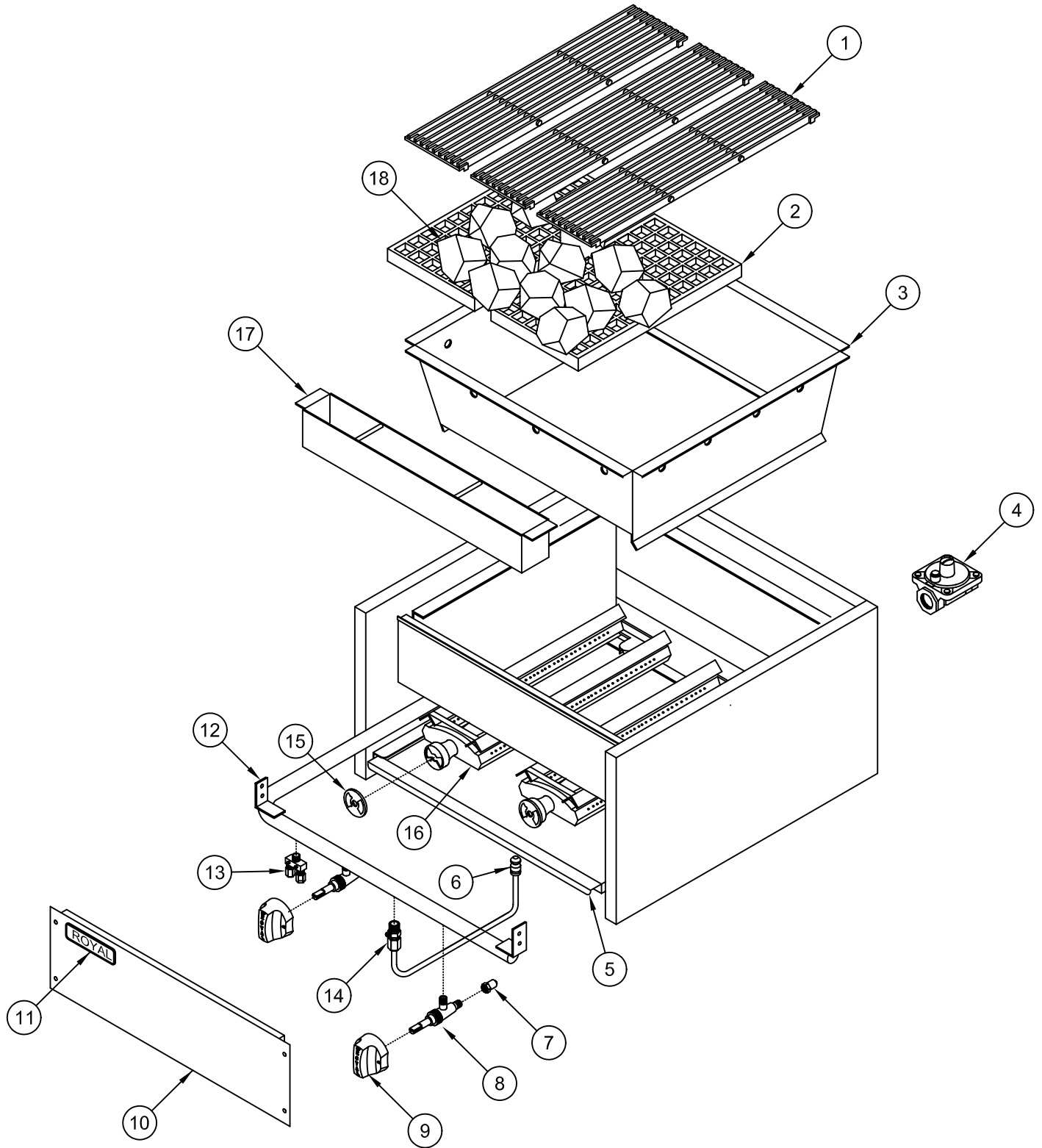

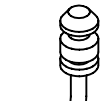



# RCB & RSCB Char-rock Broiler

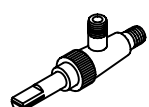

PILOT TIP ASSY	ORIFICE HOOD	GAS VALVE	ON/OFF KNOB	3/16 DUAL PILOT VALVE	SINGLE PILOT	AIR SHUTTER
 6	 7	 8	 9	 13	 14	 15

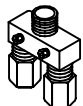
## **RCB & RSCB**

### **Char-rock Broiler**

ITEM NO.	PART NO.	DESCRIPTION
1	1800 1801	6 x 24 Top grates (cast iron) for H/D series 5 x 21 Top grates (cast iron) for snack series
2	1802 1803	4" x 20" Bottom grate (waffle grate) for H/D series 8" x 15" Bottom grate (waffle grate) for snack series
3	29901 29902 29903 29904 29905 29906 29907 29908 29909 29910 29911	RCB-18 Fire box assy. RCB-24 Fire box assy. RCB-30 Fire box assy. RCB-36 Fire box assy. RCB-48 Fire box assy. RCB-60 Fire box assy. RSCB-12 Fire box assy. RSCB-18 Fire box assy. RSCB-24 Fire box assy. RSCB-36 Fire box assy. RSCB-48 Fire box assy.
4	1618 1619	Gas pressure regulator (natural gas) Gas pressure regulator (propane Gas)
5	29734 29735 29754 29755 29774 29775 29794 29795 29814 29815 29834	RCB-18 Crumb tray RSCB-18 Crumb tray RCB-24 Crumb tray RSCB-24 Crumb tray RCB-30 Crumb tray RSCB-30 Crumb tray RCB-36 Crumb tray RSCB-36 Crumb tray RCB-48 Crumb tray RSCB-48 Crumb tray RCB-60 Crumb tray
6	1822	Pilot tip assembly
7	1121-33 1122-49 1121-36 1122-50	Orifice hood # 33 (natural gas) for H/D series, 40,000 BTU Orifice hood # 49 (propane gas) for H/D series, 40,000 BTU Orifice hood # 36 (natural gas) for snack series, 35,000 BTU Orifice hood # 50 (propane gas) for snack series, 35,000 BTU
8	1628	Gas valve (brass) w/out orifice
9	3099	Blue knob – flat side up
10	29731 29751 29771 29791 29811 29831	RCB-18/RSCB-18 Valve cover RCB-24/RSCB-24 Valve cover RCB-30/RSCB-30 Valve cover RCB-36/RSCB-36 Valve cover RCB-48/RSCB-48 Valve cover RCB-60 Valve cover

11	2648	Royal logo (Small)
12	3821	RCB-18 Manifold pipe
	3822	RCB-24 Manifold pipe
	3823	RCB-30 Manifold pipe
	3824	RCB-36 Manifold pipe
	3825	RCB-48 Manifold pipe
	3826	RCB-60 Manifold pipe
	3827	RSCB-18 Manifold pipe
	3828	RSCB-24 Manifold pipe
3829	RSCB-30 Manifold pipe	
3830	RSCB-36 Manifold pipe	
3831	RSCB-48 Manifold pipe	
13	1211	1/8" NPT x 3/16" CC Adjustable double pilot valve (brass)
14	1625	1/8" NPT x 3/16" CC Adjustable single pilot valve (brass)
15	1108	Air shutter (mixer)
16	1410	Burner (cast iron) for H/D series
	1411	Burner (cast iron) for Snack series
	1420	Burner (cast iron) for Chicken Broiler (not shown)
17	29915	RCB-18/RSCB-18 Grease can
	29916	RCB-24/RSCB-24 Grease can
	29917	RCB-30/RSCB-30 Grease can
	29918	RCB-36/RSCB-36 Grease can
	29919	RCB-48/RSCB-48 Grease can
	29920	RCB-60 Grease can
18	1871	Char-rock (20 lbs. box)